

date

Centre Number

Candidate Name _____

CAMBRIDGE INTERNATIONAL EXAMINATIONS
General Certificate of Education Advanced Level
CHEMISTRY
PAPER 4

9701/4

OCTOBER/NOVEMBER SESSION 2002

1 hour

Candidates answer on the question paper.
Additional materials:
Data Booklet.

TIME 1 hour

INSTRUCTIONS TO CANDIDATES

Write your name, Centre number and candidate number in the spaces at the top of this page.
Answer **all** questions.
Write your answers in the spaces provided on the question paper.

INFORMATION FOR CANDIDATES

The number of marks is given in brackets [] at the end of each question or part question.
You may lose marks if you do not show your working or if you do not use appropriate units.

FOR EXAMINER'S USE	
1	
2	
3	
4	
5	
6	
TOTAL	

Answer **all** the questions in the spaces provided.

- 1 (a) The following diagram shows the apparatus needed to measure the standard electrode potential of copper. In the spaces below, identify or describe what the three letters **A–C** represent.

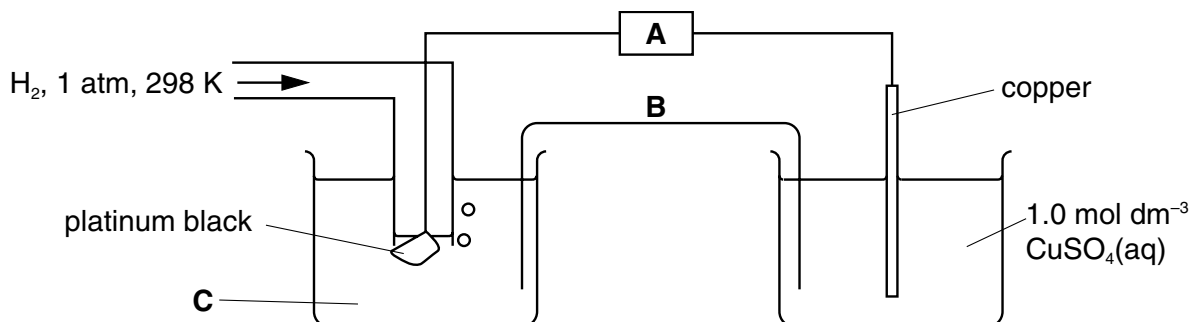

A

B

C

[3]

- (b) A student wishes to measure the standard electrode potential of the $\text{Fe}^{3+}/\text{Fe}^{2+}$ electrode. In the space below, draw and label the set-up for the right-hand beaker that would replace the one shown in the diagram above.

[2]

- (c) Predict how the E of the $\text{Fe}^{3+}/\text{Fe}^{2+}$ electrode would vary as

- (i) the $[\text{Fe}^{3+}]$ is increased,

.....

- (ii) the $[\text{Fe}^{2+}]$ is increased.

.....

[1]

- (d) An aqueous solution of iron(III) chloride is used to dissolve the excess of copper from printed-circuit boards.

Use the half-equations and E^\ominus values in the *Data Booklet* to

- (i) write an equation for this reaction,

.....

- (ii) calculate the E^\ominus_{cell} for the reaction.

.....

[2]

- (e) The solution resulting from dissolving the copper from a small printed-circuit board was acidified and titrated with $0.0200 \text{ mol dm}^{-3} \text{ KMnO}_4$. A volume of 75.0 cm^3 was required for the end point.

The equation for the titration reaction is as follows.



Calculate

- (i) the number of moles of Fe^{2+} in the solution,

- (ii) the mass of copper that had dissolved from the printed-circuit board.

[4]

[Total: 12]

- 2 (a) Write an equation to represent the lattice energy of sodium oxide, Na_2O .

.....

- (b) The Born-Haber cycle shown may be used to calculate the lattice energy of sodium oxide.

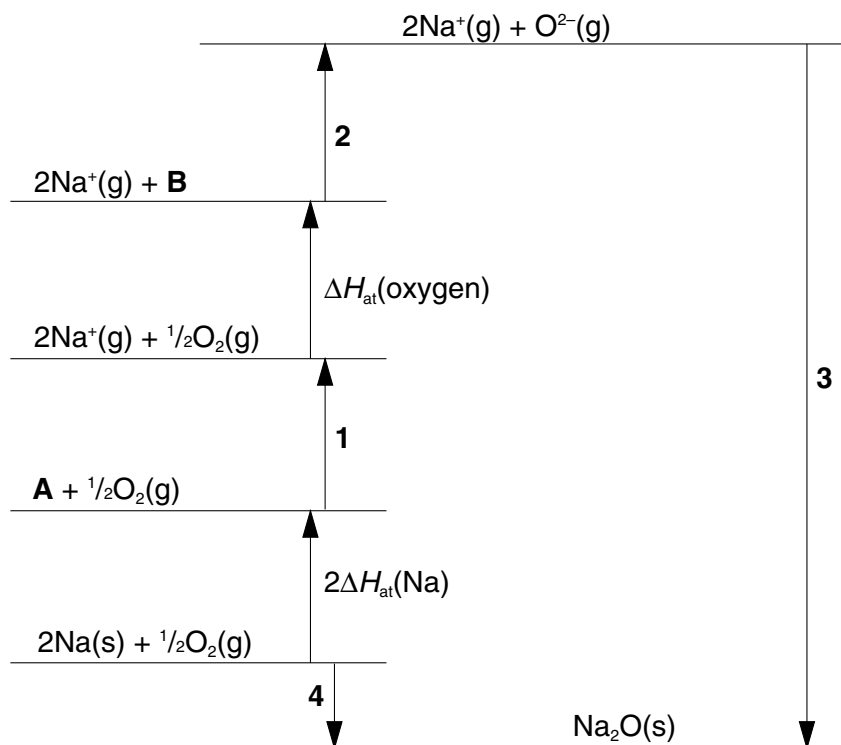

- (i) In the spaces below, identify the species **A** and **B** in the cycle, including the appropriate state symbols.

species **A** species **B**

- (ii) Identify the enthalpy changes labelled by the numbers 1 to 4 in the cycle.

1

2

3

4

[3]

- (c) Use your cycle, the following data, and further data from the *Data Booklet* to calculate the lattice energy of sodium oxide.

Data:	enthalpy change of atomisation for Na(s)	+107 kJ mol ⁻¹
	first electron affinity of oxygen	-141 kJ mol ⁻¹
	second electron affinity of oxygen	+798 kJ mol ⁻¹
	enthalpy change of formation of Na ₂ O(s)	-414 kJ mol ⁻¹
	enthalpy change of atomisation for oxygen = half the bond energy for O ₂ .	

[3]

- (d) (i) How would you expect the magnitude of lattice energy of magnesium oxide to compare with that of sodium oxide? Explain your reasoning.

.....
.....
.....

- (ii) State a use of magnesium oxide, and explain how the use relates to your answer in part (d) (i).

.....
.....

[4]

[Total: 11]

- 4 (a) The melting point and density of a typical transition element such as iron differ from those of a typical s-block element such as calcium. Describe and explain these differences.

.....

[3]

- (b) Suggest a reason why iron forms compounds containing Fe^{3+} ions as well as compounds containing Fe^{2+} ions, whereas calcium only forms compounds containing Ca^{2+} ions.

.....
[1]

- (c) An important ore of iron is siderite, iron(II) carbonate. The first step in converting it into iron is to heat it in air. When heated in air, both calcium carbonate and iron(II) carbonate decompose, but in different ways.

- (i) Write an equation to represent the thermal decomposition of calcium carbonate.

.....

- (ii) When siderite is heated in air, carbon dioxide is evolved and iron(III) oxide, Fe_2O_3 , is left.

Construct an equation for this reaction.

.....

- (iii) Calculate how much iron(III) oxide can be obtained by heating 10 tonnes of siderite.

.....

.....

[4]

[Total: 8]

- 5 Benzene can be converted into nitrobenzene by a nitration reaction.

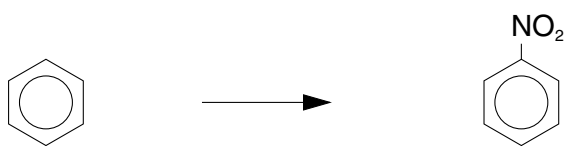

- (a) State the reagents and conditions necessary to carry out this reaction.

.....
 [2]

- (b) What type of reaction mechanism is this?

..... [1]

- (c) The reaction proceeds via two steps:

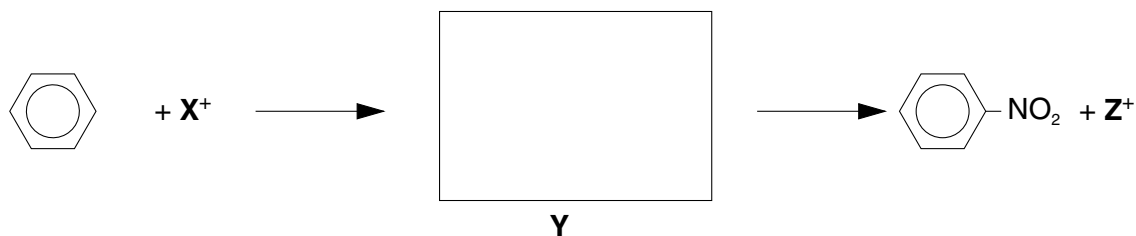

- (i) Draw the structure of the intermediate **Y** in the box.
- (ii) Identify the cation **X⁺**.....
- (iii) Identify the cation **Z⁺**.....
- (iv) Write an equation to show how **X⁺** is produced from the reagents.

..... [5]

- (d) Some aromatic poly-nitro compounds are used in perfumes as artificial musk. One example is 'Baur musk'.

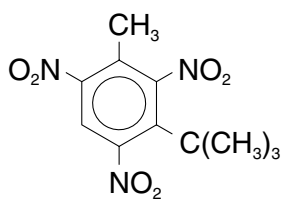

Baur musk

- (i) Draw the structural formula of the hydrocarbon that could be nitrated in order to produce Baur musk.
- (ii) Suggest the structural formula of the compound formed by reacting Baur musk with an excess of tin and concentrated hydrochloric acid.

[2]

[Total: 10]

- 6 Amides can be made by reacting amines with acyl chlorides, as in the example below

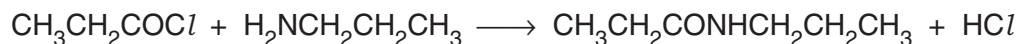

- (a) What type of reaction mechanism is this?

.....[1]

- (b) What compound could $\text{CH}_3\text{CH}_2\text{COCl}$ be made from, and what reagent would you use?

.....
.....[2]

- (c) The amine $\text{CH}_3\text{CH}_2\text{CH}_2\text{NH}_2$ can be made from $\text{CH}_3\text{CH}_2\text{Br}$ in two steps.



- (i) Draw the structural formula of the intermediate in the box provided.

.....

- (ii) State the reagents and conditions for step I.

.....

- (iii) State the reagents and conditions for step II.

.....

[4]

- (d) *Kevlar* is a low weight, high strength polyamide used as a reinforcement in car aircraft wings and in bullet-proof vests. A portion of its chain is shown below.

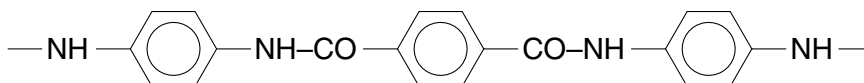

- (i) What type of polymerisation produces *Kevlar*?

.....

- (ii) Draw the structural formulae of the monomers from which *Kevlar* is made.

- (iii) Suggest a reason why *Kevlar* is much stronger than most other polyamides.

.....

- (iv) What reaction conditions are needed to break the amide bonds in *Kevlar*?

.....

[4]

[Total: 11]

